



# Product Specification

Product Name : ONN-LED Machine Light

Model No. : ONN-M10A Series

Date : 2014-06-18

1. Image and drawing:

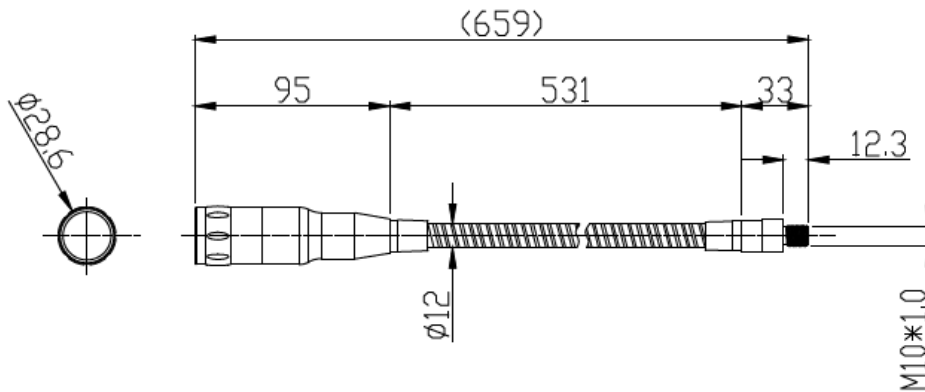

Besides 530mm, Gooseneck also has 730mm option.

Base options:



Magnetic base  
 $\phi 6$  screw hole



Fixed by screw thread  
M10\*1.0 thread



With PC base  
 $\phi 6$  screw hole

## 2. Spec Data:

Model	Input Volt	Input Volt	CCT
□ ONN-M10A-B1	AC/DC 24V	AC/DC 24±2V	5500-6000K
□ ONN-M10A-B2	AC/DC 24V	AC/DC 24±2V	3000-3500K
Length of Cable	■ About 0.3M (Standard), no plug fitted.		
Mounting	■ Fixed with screw thread(Standard) ■ By magnet base ■ By PC base		
Consumed Power	2.5W		
Input Current	(24V)180 mA		
Flux	100 Lm		

IP Protection	IP65	CCT	5500—6000K	4000-4500K
Luminous Efficiency	40Lm/W	CRI	≧ 70Ra	
Driver	External, Isolated	PF	≧ 0.9	
Surface temperature	< 60°C	View Angle	15°	
Life span	50 000H			

## 3. Photometric Data:

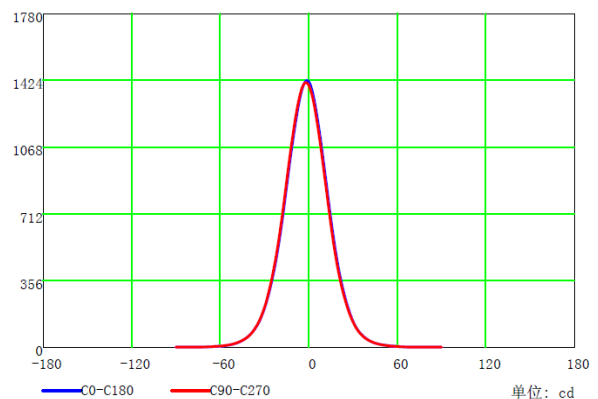
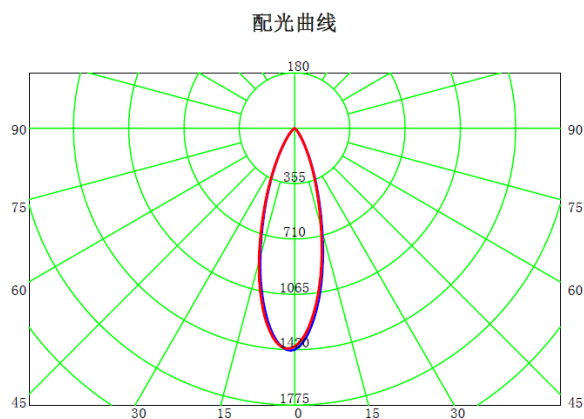

4. Average Luminance:

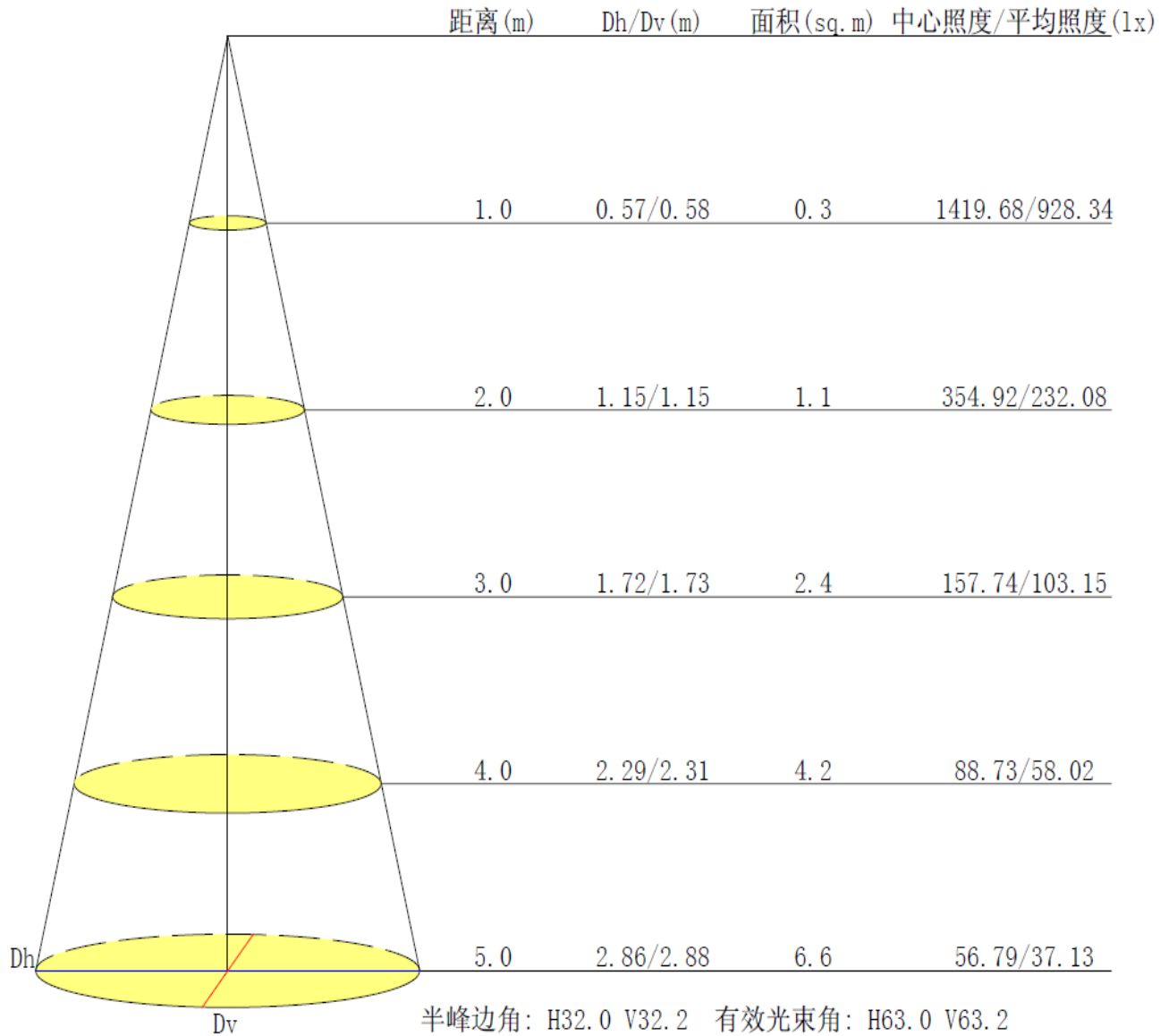

5. Package Data:

Packing material	Carton Box
Model Name (MM)	660
Net Weight / Pc (Kg)	0.507
Gross Weight / Cnt (Kg)	32.75
Packing Qty (PCS)	60
Inner box size (L*W*H) mm	770*60*70
Outer box size (L*W*H) mm	780*285*233

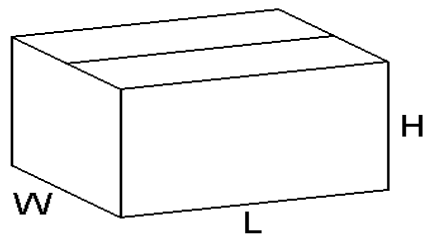
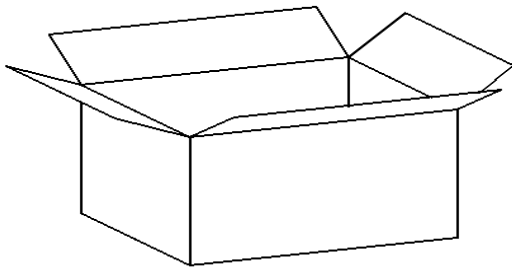

6. Wiring

**24V cable**

AC/DC24V  
Red/positive pole

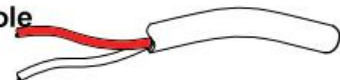

AC/DC24V  
White/negative pole